

Pneumatic Quick Couplings

General Purpose – Manual Connect

10 Series, 20 Series, 50 Series, 70 Series

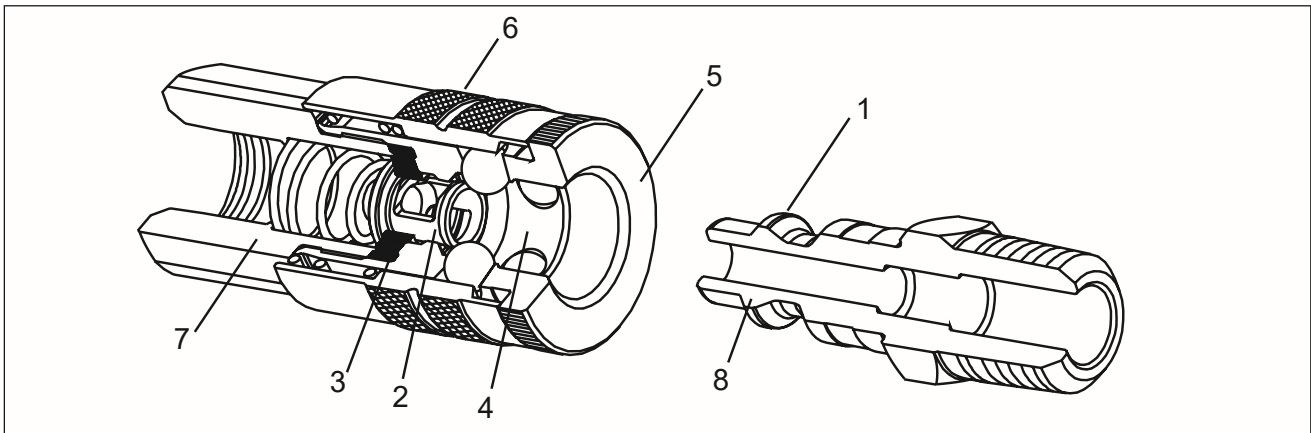

Component Part Features for Manual Couplers, Series 10, 20, 50 & 70 Series

1. Precision machining, hardened wear points* and solid barstock construction provide long life even in rugged applications.
2. Tubular valve with large flow passages delivers high air flow with minimal pressure drop for efficient performance. The tubular design provides 360° support for both the valve seal and the mating nipple for long service life.
3. Precision molded seals form a “bubble tight” seal for reliable operation within rated working pressures. Standard seal material is Nitrile. Ethylene Propylene, Fluorocarbon and Neoprene seals are available as options.
4. Proven ball locking mechanism with large numbers of hardened steel or stainless steel locking balls evenly distribute the load to resist wear and provide positive connections. The ball locking mechanism also provides accurate alignment and allows a swiveling action to reduce hose torque.
5. Integral sleeve guard protects the sleeve and resists accidental disconnects by allowing the coupling to ride over obstructions without the sleeve being retracted.
6. Knurling and/or grooves on sleeve provide a gripping surface for ease of operation.
7. Wide range of body sizes, materials, options and end terminations are available to meet specific needs. Parker sleeve type couplings are available with male pipe thread, female pipe thread, standard hose barb, Push-Lok hose barb**, and reusable hose fitting ends. Standard body materials are brass in 1/4" body size and steel in larger sizes.
8. Parker sleeve type couplings are available in interchanges for industrial interchange, Tru-flate, ARO 210 and Lincoln long stem design nipples.

* Steel nipples only.

** Push-lok hose barbs are designed for use with Parker Push-lok hose and do not require clamps.

Accessories - Coupler Options

Grip-Ring Sleeve - Features

- This Grip-Ring sleeve enables the operator to connect or disconnect the coupling easily, even with greasy hands or while wearing heavy gloves.
- Grip-Ring sleeves are available for all 10 and 20 Series couplers (only). **To specify a model with a Grip-Ring sleeve, add the suffix letter “R” to the regular model number. Example: B13R.**



Caution: The Grip-Ring sleeve is subject to unintended disconnect if dragged on the end of a hose. Do not attempt to pull it over obstacles.

Sleeve-Lok - Features

- All sizes of 10, 20, 30, 50, and 70 Series couplers (only) can be furnished with Locking Sleeves, as illustrated.
- Place suffix letters -“SL” (Sleeve-Lok) after regular catalog number. Example: B13-SL.

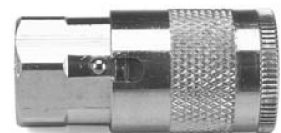

Coupler Repair Kits for 10, 20, 30, 50, 70, & TL Series

Body Size	Seal Material	Part No.
1/4	Nitrile	21K
1/4	Ethylene Propylene	21KW
1/4	Fluorocarbon	21KY
3/8	Nitrile	14K
3/8	Ethylene Propylene	14KW
3/8	Fluorocarbon	14KY
1/2	Nitrile	16K
1/2	Ethylene Propylene	16KW
1/2	Fluorocarbon	16KY
3/4	Nitrile	38K
3/4	Ethylene Propylene	38KW
3/4	Fluorocarbon	38KY

Pneumatic Quick Couplings

General Purpose – Manual Connect 10 Series



Features

- Parker 10 Series couplings are the original Tru-Flate design.
- This unique design has been field proven as a long lasting, high performance coupling especially when used with pneumatic tools.
- Standard seals are Nitrile. See the Coupling Selection and Ordering Information Guide at the beginning of Section A and the Fluid Compatibility Chart at the end of this catalog for optional materials.

Specifications

Body Size (in.)	1/4	3/8	1/2
Rated Pressure (PSI)	300	300	300
Temperature Range (Std. seals)*	-40° to +250° F.		
Locking Device	4 balls	8 balls	8 balls
Vacuum Data (inches Hg)	Not recommended		
Disconnected (coupler only)	Not recommended		
Connected	27.4	27.4	27.4

* See Coupling Selection and Ordering Guide for Optional Seals
See **Coupling Repair Kits** Table on introduction page to General Purpose - Manual Connect Couplers.

Applications

Sleeve type couplings are widely used to connect air lines and can also be used with low pressure fluids.

Their compact and economical design uses a ball locking mechanism consisting of captive steel balls that engage the locking groove on the mating nipple. The sliding spring loaded sleeve on the coupler must be manually retracted in order to connect or disconnect the nipple. It is easy to do, but two hands are normally required.

Common applications include: compressed air, water, grease, paint, limited vacuum and limited gases.

How to Order Information

The standard 1/4" 10 Series features a brass coupler with a steel valve. Larger sizes include an all steel construction with brass also available. To order a 3/8" or 1/2" coupler with a brass body and steel sleeve, add the prefix "B" to the steel part number, Example: B15.

Add the suffix "N" as well as the "B" prefix to order an all brass coupler with stainless steel locking balls and springs, Example: B15N.

All-brass couplings should be used to avoid corrosion from moisture. Consult factory for specific recommendations.

Available with Sleeve-Lok (See Coupler Options). To order, add the suffix "-SL" to the part number, Example: 15-SL.

Available for 1/4" 10 Series couplers is a Grip-Ring Sleeve (See Coupler Options). To order add the suffix "R" to the part number, Example: B13R.

Performance

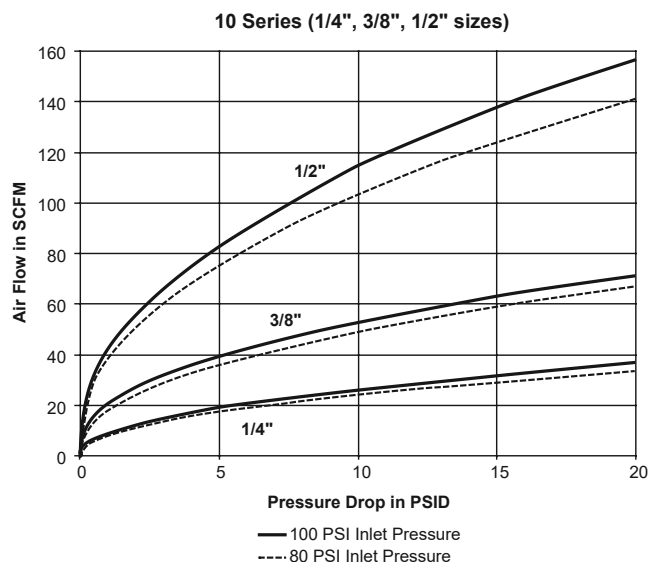

Pneumatic Quick Couplings

General Purpose – Manual Connect 10 Series

Couplers

Female Pipe Thread

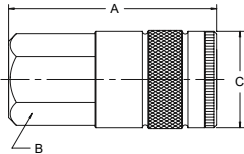
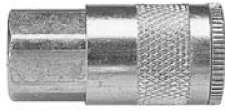

Body Size (in.)	Part No. Brass	Part No. Steel	Thread Size NPTF	Dimensions (in.)			Wt. (LB) P/Piece
				Overall Length	Hex Size	Largest Diameter	
				A	B	C	
1/4	B13A	–	1/8-27	1.83	0.75	0.90	0.19
1/4	B13	–	1/4-18	1.83	0.75	0.90	0.19
1/4	B13E	–	3/8-18	1.95	0.81	0.94	0.31
3/8	–	15C	1/4-18	2.22	0.88	1.06	0.30
3/8	B15	15	3/8-18	2.28	0.88	1.06	0.34
3/8	–	15F	1/2-14	2.55	1.00	1.16	0.46
1/2	–	17E	3/8-18	2.74	1.00	1.19	0.46
1/2	B17	17	1/2-14	2.96	1.00	1.19	0.50
1/2	–	17G	3/4-14	3.19	1.25	1.44	0.20

Male Pipe Thread

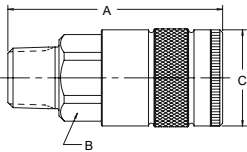

Body Size (in.)	Part No. Brass	Part No. Steel	Thread Size NPTF	Dimensions (in.)			Wt. (LB) P/Piece
				Overall Length	Hex Size	Largest Diameter	
				A	B	C	
1/4	B12A	–	1/8-27	1.89	0.75	0.90	0.17
1/4	B12	–	1/4-18	2.05	0.75	0.90	0.18
1/4	B12E	–	3/8-18	2.08	0.75	0.90	0.19
3/8	–	14C	1/4-18	2.36	0.88	1.06	0.26
3/8	B14	14	3/8-18	2.39	0.88	1.06	0.27
3/8	–	14F	1/2-14	2.55	0.88	1.06	0.28
1/2	–	16E	3/8-18	2.93	1.00	1.19	0.42
1/2	B16	16	1/2-14	3.08	1.00	1.19	0.45
1/2	–	16G	3/4-14	3.21	1.13	1.30	0.50

Standard Hose Barb

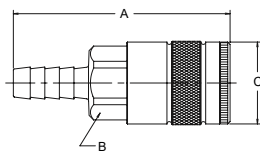

Body Size (in.)	Part No. Brass	Part No. Steel	Hose I.D.	Dimensions (in.)			Wt. (LB) P/Piece
				Overall Length	Hex Size	Largest Diameter	
				A	B	C	
1/4	B10-3B	–	1/4	2.49	0.75	0.90	0.18
1/4	B10-4B	–	5/16	2.49	0.75	0.90	–
1/4	B10-5B	–	3/8	2.49	0.75	0.90	0.18
3/8	–	14-5B	3/8	2.86	0.88	1.06	0.26
3/8	–	14-6B	1/2	3.08	0.88	1.06	0.27
1/2	–	16-5B	3/8	3.37	1.00	1.19	0.41
1/2	–	16-6B	1/2	3.62	1.00	1.19	0.43
1/2	–	16-7B	3/4	3.96	1.00	1.19	0.48

Push-Lok Hose Barb*

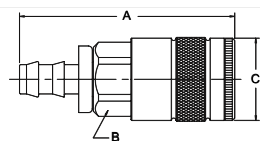

Body Size (in.)	Part No. Brass	Part No. Steel	Hose I.D.	Dimensions (in.)			Wt. (LB) P/Piece
				Overall Length	Hex Size	Largest Diameter	
				A	B	C	
1/4	B10-3BP	–	1/4	2.32	0.75	0.90	0.19
1/4	B10-5BP	–	3/8	2.47	0.75	0.90	0.19
3/8	–	14-5BP	3/8	2.88	0.88	1.06	0.26
1/2	–	16-5BP	3/8	3.35	1.00	1.19	0.40
1/2	–	16-6BP	1/2	3.46	1.00	1.19	0.43

* Push-Lok hose barbs are designed for use with Parker Push-Lok hose and do not require clamps.

Pneumatic Quick Couplings

General Purpose – Manual Connect 10 Series

Nipples

Female Pipe Thread

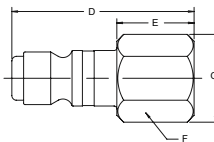

Body Size (in.)	Part No. Brass	Part No. Steel	Thread Size NPTF	Overall Length	Dimensions (in.)				Wt. (LB) P/Piece
					Exposed Length*	Hex Size	Largest Diameter		
				D	E	F	G		
1/4	–	1C	1/8-27	1.28	0.55	0.50	0.58	0.05	
1/4	B3C	3C	1/4-18	1.47	0.74	0.62	0.72	0.05	
1/4	–	3C-E	3/8-18	1.50	0.77	0.81	0.94	0.07	
3/8	–	1E	1/4-18	1.60	0.67	0.62	0.72	0.07	
3/8	–	3E	3/8-18	1.68	0.77	0.81	0.94	0.10	
1/2	–	1F	3/8-18	2.05	0.83	0.81	0.94	0.13	
1/2	–	3F	1/2-14	2.27	1.05	1.00	1.16	0.18	
1/2	–	H3F-G	3/4-14	2.38	1.13	1.25	1.44	0.26	

* This dimension represents portion of nipple that is exposed when nipple is inserted in a Parker 10 Series coupler.

Male Pipe Thread

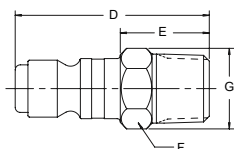

Body Size (in.)	Part No. Brass	Part No. Steel	Part No. Type 303 Stainless	Thread Size NPTF	Overall Length	Dimensions (in.)				Wt. (LB) P/Piece	
						Exposed Length*	Hex Size	Largest Diameter			
						D	E	F	G		
1/4	–	0C	–	1/8-27	1.47	0.74	0.50	0.58	0.04		
1/4	B2C	2C	S2C	1/4-18	1.62	0.89	0.56	0.65	0.06		
1/4	–	2C-E	–	3/8-18	1.72	0.99	0.69	0.80	0.05		
3/8	–	0E	–	1/4-18	1.88	0.95	0.62	0.72	0.08		
3/8	–	2E	–	3/8-18	1.90	0.98	0.69	0.80	0.09		
1/2	–	0F	–	3/8-18	2.33	1.12	0.69	0.79	0.13		
1/2	–	2F	–	1/2-14	2.48	1.27	0.88	1.01	0.17		
1/2	–	H2F-G	–	3/4-14	2.53	1.29	1.13	1.30	0.24		

* This dimension represents portion of nipple that is exposed when nipple is inserted in a Parker 10 Series coupler.

Standard Hose Barb

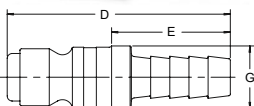

Body Size (in.)	Part No. Steel	Hose I.D.	Overall Length	Dimensions (in.)			Wt. (LB) P/Piece	
				Exposed Length*	Largest Diameter			
				D	E	G		
1/4	8C	1/4	1.63	.090	0.45	0.04		
1/4	9C	3/8	2.00	1.27	0.55	0.05		
3/8	5E	3/8	1.81	0.89	0.59	0.07		
1/2	H4F	3/8	2.53	1.29	0.69	0.08		
1/2	5F	1/2	2.81	1.60	0.81	0.11		
1/2	H5F-G	3/4	3.16	1.91	0.94	0.18		

* This dimension represents portion of nipple that is exposed when nipple is inserted in a Parker 10 Series coupler.

Push-Lok Hose Barb**

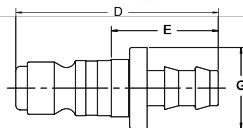
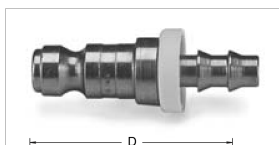

Body Size (in.)	Part No. Steel	Hose I.D.	Overall Length	Dimensions (in.)			Wt. (LB) P/Piece	
				Exposed Length*	Largest Diameter			
				D	E	G		
1/4	8CP	1/4	1.66	0.93	0.45	0.04		
1/4	9CP	3/8	1.98	1.25	0.86	0.05		
3/8	5EP	3/8	1.98	1.06	0.59	0.08		
1/2	H4FP	3/8	2.52	1.27	0.86	0.11		
1/2	H5FP	1/2	2.66	1.42	0.97	0.11		

* This dimension represents portion of nipple that is exposed when nipple is inserted in a Parker 10 Series coupler.

** Push-Lok hose barbs are designed for use with Parker Push-Lok hose and do not require clamps.